

## I/O Devices

Before delving into the main content of this part of the book (on persistence), we first introduce the concept of an **input/output (I/O) device** and show how the operating system might interact with such an entity. I/O is quite critical to computer systems, of course; imagine a program without any input (it produces the same result each time); now imagine a program with no output (what was the purpose of it running?). Clearly, for computer systems to be interesting, both input and output are required. And thus, our general problem:

### CRUX: HOW TO INTEGRATE I/O INTO SYSTEMS

How should I/O be integrated into systems? What are the general mechanisms? How can we make them efficient?

### 36.1 System Architecture

To begin our discussion, let's look at the structure of a typical system (Figure 36.1). The picture shows a single CPU attached to the main memory of the system via some kind of **memory bus** or interconnect. Some devices are connected to the system via a general **I/O bus**, which in many modern systems would be **PCI** (or one of its many derivatives); graphics and some other higher-performance I/O devices might be found here. Finally, even lower down are one or more of what we call a **peripheral bus**, such as **SCSI**, **SATA**, or **USB**. These connect the slowest devices to the system, including **disks**, **mice**, and other similar components.

One question you might ask is: why do we need a hierarchical structure like this? Put simply: physics, and cost. The faster a bus is, the shorter it must be; thus, a high-performance memory bus does not have much room to plug devices and such into it. In addition, engineering a bus for high performance is quite costly. Thus, system designers have adopted this hierarchical approach, where components that demand high performance (such as the graphics card) are nearer the CPU. Lower per-

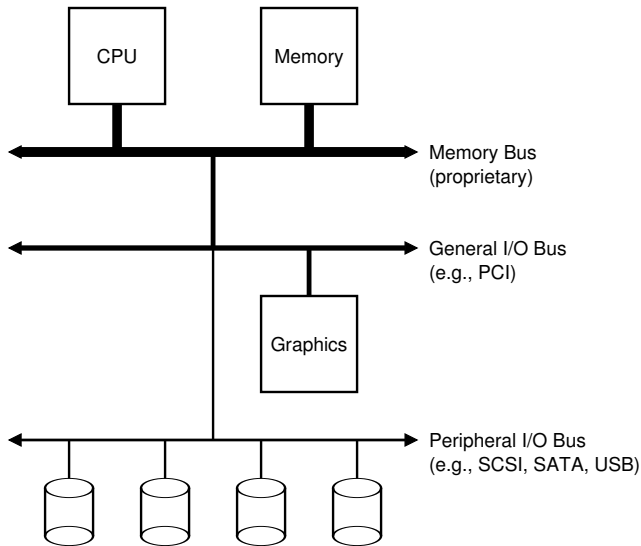

Figure 36.1: Prototypical System Architecture

formance components are further away. The benefits of placing disks and other slow devices on a peripheral bus are manifold; in particular, you can place a large number of devices on it.

## 36.2 A Canonical Device

Let us now look at a canonical device (not a real one), and use this device to drive our understanding of some of the machinery required to make device interaction efficient. From Figure 36.2, we can see that a device has two important components. The first is the hardware **interface** it presents to the rest of the system. Just like a piece of software, hardware must also present some kind of interface that allows the system software to control its operation. Thus, all devices have some specified interface and protocol for typical interaction.

The second part of any device is its **internal structure**. This part of the device is implementation specific and is responsible for implementing the abstraction the device presents to the system. Very simple devices will have one or a few hardware chips to implement their functionality; more complex devices will include a simple CPU, some general purpose memory, and other device-specific chips to get their job done. For example, modern RAID controllers might consist of hundreds of thousands of lines of **firmware** (i.e., software within a hardware device) to implement its functionality.

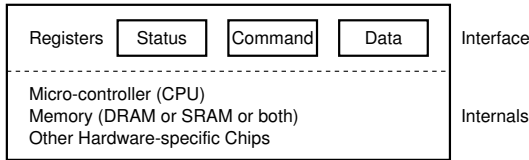

Figure 36.2: A Canonical Device

### 36.3 The Canonical Protocol

In the picture above, the (simplified) device interface is comprised of three registers: a **status** register, which can be read to see the current status of the device; a **command** register, to tell the device to perform a certain task; and a **data** register to pass data to the device, or get data from the device. By reading and writing these registers, the operating system can control device behavior.

Let us now describe a typical interaction that the OS might have with the device in order to get the device to do something on its behalf. The protocol is as follows:

```

While (STATUS == BUSY)
    ; // wait until device is not busy
Write data to DATA register
Write command to COMMAND register
    (Doing so starts the device and executes the command)
While (STATUS == BUSY)
    ; // wait until device is done with your request

```

The protocol has four steps. In the first, the OS waits until the device is ready to receive a command by repeatedly reading the status register; we call this **polling** the device (basically, just asking it what is going on). Second, the OS sends some data down to the data register; one can imagine that if this were a disk, for example, that multiple writes would need to take place to transfer a disk block (say 4KB) to the device. When the main CPU is involved with the data movement (as in this example protocol), we refer to it as **programmed I/O (PIO)**. Third, the OS writes a command to the command register; doing so implicitly lets the device know that both the data is present and that it should begin working on the command. Finally, the OS waits for the device to finish by again polling it in a loop, waiting to see if it is finished (it may then get an error code to indicate success or failure).

This basic protocol has the positive aspect of being simple and working. However, there are some inefficiencies and inconveniences involved. The first problem you might notice in the protocol is that polling seems inefficient; specifically, it wastes a great deal of CPU time just waiting for the (potentially slow) device to complete its activity, instead of switching to another ready process and thus better utilizing the CPU.

THE CRUX: HOW TO AVOID THE COSTS OF POLLING

How can the OS check device status without frequent polling, and thus lower the CPU overhead required to manage the device?

### 36.4 Lowering CPU Overhead With Interrupts

The invention that many engineers came upon years ago to improve this interaction is something we've seen already: the **interrupt**. Instead of polling the device repeatedly, the OS can issue a request, put the calling process to sleep, and context switch to another task. When the device is finally finished with the operation, it will raise a hardware interrupt, causing the CPU to jump into the OS at a pre-determined **interrupt service routine (ISR)** or more simply an **interrupt handler**. The handler is just a piece of operating system code that will finish the request (for example, by reading data and perhaps an error code from the device) and wake the process waiting for the I/O, which can then proceed as desired.

Interrupts thus allow for **overlap** of computation and I/O, which is key for improved utilization. This timeline shows the problem:

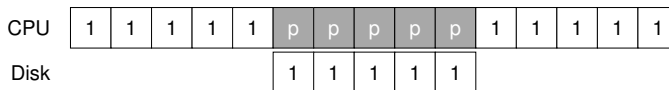

In the diagram, Process 1 runs on the CPU for some time (indicated by a repeated 1 on the CPU line), and then issues an I/O request to the disk to read some data. Without interrupts, the system simply spins, polling the status of the device repeatedly until the I/O is complete (indicated by a p). The disk services the request and finally Process 1 can run again.

If instead we utilize interrupts and allow for overlap, the OS can do something else while waiting for the disk:

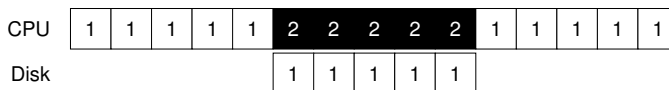

In this example, the OS runs Process 2 on the CPU while the disk services Process 1's request. When the disk request is finished, an interrupt occurs, and the OS wakes up Process 1 and runs it again. Thus, *both* the CPU and the disk are properly utilized during the middle stretch of time.

Note that using interrupts is *not always* the best solution. For example, imagine a device that performs its tasks very quickly: the first poll usually finds the device to be done with task. Using an interrupt in this case will actually *slow down* the system: switching to another process, handling the interrupt, and switching back to the issuing process is expensive. Thus, if a device is fast, it may be best to poll; if it is slow, interrupts, which allow

## TIP: INTERRUPTS NOT ALWAYS BETTER THAN PIO

Although interrupts allow for overlap of computation and I/O, they only really make sense for slow devices. Otherwise, the cost of interrupt handling and context switching may outweigh the benefits interrupts provide. There are also cases where a flood of interrupts may overload a system and lead it to livelock [MR96]; in such cases, polling provides more control to the OS in its scheduling and thus is again useful.

overlap, are best. If the speed of the device is not known, or sometimes fast and sometimes slow, it may be best to use a **hybrid** that polls for a little while and then, if the device is not yet finished, uses interrupts. This **two-phased** approach may achieve the best of both worlds.

Another reason not to use interrupts arises in networks [MR96]. When a huge stream of incoming packets each generate an interrupt, it is possible for the OS to **livelock**, that is, find itself only processing interrupts and never allowing a user-level process to run and actually service the requests. For example, imagine a web server that suddenly experiences a high load due to the “slashdot effect”. In this case, it is better to occasionally use polling to better control what is happening in the system and allow the web server to service some requests before going back to the device to check for more packet arrivals.

Another interrupt-based optimization is **coalescing**. In such a setup, a device which needs to raise an interrupt first waits for a bit before delivering the interrupt to the CPU. While waiting, other requests may soon complete, and thus multiple interrupts can be coalesced into a single interrupt delivery, thus lowering the overhead of interrupt processing. Of course, waiting too long will increase the latency of a request, a common trade-off in systems. See Ahmad et al. [A+11] for an excellent summary.

## 36.5 More Efficient Data Movement With DMA

Unfortunately, there is one other aspect of our canonical protocol that requires our attention. In particular, when using programmed I/O (PIO) to transfer a large chunk of data to a device, the CPU is once again overburdened with a rather trivial task, and thus wastes a lot of time and effort that could better be spent running other processes. This timeline illustrates the problem:

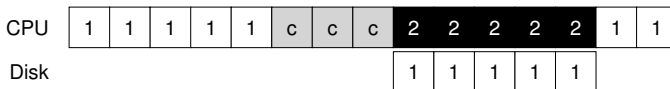

In the timeline, Process 1 is running and then wishes to write some data to the disk. It then initiates the I/O, which must copy the data from memory to the device explicitly, one word at a time (marked *c* in the diagram). When the copy is complete, the I/O begins on the disk and the CPU can finally be used for something else.

THE CRUX: HOW TO LOWER PIO OVERHEADS

With PIO, the CPU spends too much time moving data to and from devices by hand. How can we offload this work and thus allow the CPU to be more effectively utilized?

The solution to this problem is something we refer to as **Direct Memory Access (DMA)**. A DMA engine is essentially a very specific device within a system that can orchestrate transfers between devices and main memory without much CPU intervention.

DMA works as follows. To transfer data to the device, for example, the OS would program the DMA engine by telling it where the data lives in memory, how much data to copy, and which device to send it to. At that point, the OS is done with the transfer and can proceed with other work. When the DMA is complete, the DMA controller raises an interrupt, and the OS thus knows the transfer is complete. The revised timeline:

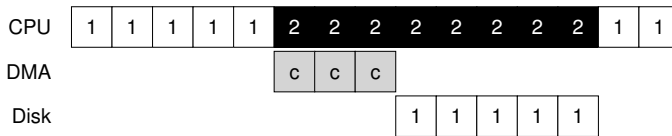

From the timeline, you can see that the copying of data is now handled by the DMA controller. Because the CPU is free during that time, the OS can do something else, here choosing to run Process 2. Process 2 thus gets to use more CPU before Process 1 runs again.

### 36.6 Methods Of Device Interaction

Now that we have some sense of the efficiency issues involved with performing I/O, there are a few other problems we need to handle to incorporate devices into modern systems. One problem you may have noticed thus far: we have not really said anything about how the OS actually communicates with the device! Thus, the problem:

THE CRUX: HOW TO COMMUNICATE WITH DEVICES

How should the hardware communicate with a device? Should there be explicit instructions? Or are there other ways to do it?

Over time, two primary methods of device communication have developed. The first, oldest method (used by IBM mainframes for many years) is to have explicit **I/O instructions**. These instructions specify a way for the OS to send data to specific device registers and thus allow the construction of the protocols described above.

For example, on x86, the `in` and `out` instructions can be used to communicate with devices. For example, to send data to a device, the caller specifies a register with the data in it, and a specific *port* which names the device. Executing the instruction leads to the desired behavior.

Such instructions are usually **privileged**. The OS controls devices, and the OS thus is the only entity allowed to directly communicate with them. Imagine if any program could read or write the disk, for example: total chaos (as always), as any user program could use such a loophole to gain complete control over the machine.

The second method to interact with devices is known as **memory-mapped I/O**. With this approach, the hardware makes device registers available as if they were memory locations. To access a particular register, the OS issues a load (to read) or store (to write) the address; the hardware then routes the load/store to the device instead of main memory.

There is not some great advantage to one approach or the other. The memory-mapped approach is nice in that no new instructions are needed to support it, but both approaches are still in use today.

## 36.7 Fitting Into The OS: The Device Driver

One final problem we will discuss: how to fit devices, each of which have very specific interfaces, into the OS, which we would like to keep as general as possible. For example, consider a file system. We'd like to build a file system that worked on top of SCSI disks, IDE disks, USB keychain drives, and so forth, and we'd like the file system to be relatively oblivious to all of the details of how to issue a read or write request to these difference types of drives. Thus, our problem:

### THE CRUX: HOW TO BUILD A DEVICE-NEUTRAL OS

How can we keep most of the OS device-neutral, thus hiding the details of device interactions from major OS subsystems?

The problem is solved through the age-old technique of **abstraction**. At the lowest level, a piece of software in the OS must know in detail how a device works. We call this piece of software a **device driver**, and any specifics of device interaction are encapsulated within.

Let us see how this abstraction might help OS design and implementation by examining the Linux file system software stack. Figure 36.3 is a rough and approximate depiction of the Linux software organization. As you can see from the diagram, a file system (and certainly, an application above) is completely oblivious to the specifics of which disk class it is using; it simply issues block read and write requests to the generic block layer, which routes them to the appropriate device driver, which handles the details of issuing the specific request. Although simplified, the diagram shows how such detail can be hidden from most of the OS.

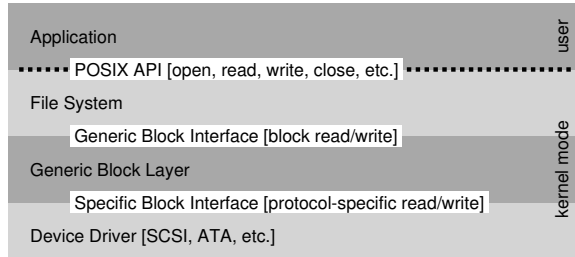

Figure 36.3: The File System Stack

Note that such encapsulation can have its downside as well. For example, if there is a device that has many special capabilities, but has to present a generic interface to the rest of the kernel, those special capabilities will go unused. This situation arises, for example, in Linux with SCSI devices, which have very rich error reporting; because other block devices (e.g., ATA/IDE) have much simpler error handling, all that higher levels of software ever receive is a generic `EIO` (generic IO error) error code; any extra detail that SCSI may have provided is thus lost to the file system [G08].

Interestingly, because device drivers are needed for any device you might plug into your system, over time they have come to represent a huge percentage of kernel code. Studies of the Linux kernel reveal that over 70% of OS code is found in device drivers [C01]; for Windows-based systems, it is likely quite high as well. Thus, when people tell you that the OS has millions of lines of code, what they are really saying is that the OS has millions of lines of device-driver code. Of course, for any given installation, most of that code may not be active (i.e., only a few devices are connected to the system at a time). Perhaps even depressingly, as drivers are often written by “amateurs” (instead of full-time kernel developers), they tend to have many more bugs and thus are a primary contributor to kernel crashes [S03].

## 36.8 Case Study: A Simple IDE Disk Driver

To dig a little deeper here, let’s take a quick look at an actual device: an IDE disk drive [L94]. We summarize the protocol as described in this reference [W10]; we’ll also peek at the `xv6` source code for a simple example of a working IDE driver [CK+08].

An IDE disk presents a simple interface to the system, consisting of four types of register: control, command block, status, and error. These registers are available by reading or writing to specific “I/O addresses” (such as `0x3F6` below) using (on `x86`) the `in` and `out` I/O instructions.



```

Control Register:
  Address 0x3F6 = 0x80 (0000 1RE0): R=reset, E=0 means "enable interrupt"

Command Block Registers:
  Address 0x1F0 = Data Port
  Address 0x1F1 = Error
  Address 0x1F2 = Sector Count
  Address 0x1F3 = LBA low byte
  Address 0x1F4 = LBA mid byte
  Address 0x1F5 = LBA hi byte
  Address 0x1F6 = 1B1D TOP4LBA: B=LBA, D=drive
  Address 0x1F7 = Command/status

Status Register (Address 0x1F7):
  7       6       5       4       3       2       1       0
  BUSY  READY  FAULT  SEEK  DRQ    CORR  IDDEX  ERROR

Error Register (Address 0x1F1): (check when Status ERROR==1)
  7       6       5       4       3       2       1       0
  BBK    UNC    MC    IDNF  MCR   ABRT  TONF  AMNF

BBK = Bad Block
UNC = Uncorrectable data error
MC  = Media Changed
IDNF = ID mark Not Found
MCR = Media Change Requested
ABRT = Command aborted
TONF = Track 0 Not Found
AMNF = Address Mark Not Found

```

Figure 36.4: The IDE Interface

The basic protocol to interact with the device is as follows, assuming it has already been initialized.

- **Wait for drive to be ready.** Read Status Register (0x1F7) until drive is not busy and READY.
- **Write parameters to command registers.** Write the sector count, logical block address (LBA) of the sectors to be accessed, and drive number (master=0x00 or slave=0x10, as IDE permits just two drives) to command registers (0x1F2-0x1F6).
- **Start the I/O.** by issuing read/write to command register. Write READ—WRITE command to command register (0x1F7).
- **Data transfer (for writes):** Wait until drive status is READY and DRQ (drive request for data); write data to data port.
- **Handle interrupts.** In the simplest case, handle an interrupt for each sector transferred; more complex approaches allow batching and thus one final interrupt when the entire transfer is complete.
- **Error handling.** After each operation, read the status register. If the ERROR bit is on, read the error register for details.

Most of this protocol is found in the xv6 IDE driver (Figure 36.5), which (after initialization) works through four primary functions. The first is `ide_rw()`, which queues a request (if there are others pending), or issues it directly to the disk (via `ide_start_request()`); in either

```

static int ide_wait_ready() {
    while (((int r = inb(0x1f7)) & IDE_BSY) || !(r & IDE_DRDY))
        ; // loop until drive isn't busy
}

static void ide_start_request(struct buf *b) {
    ide_wait_ready();
    outb(0x3f6, 0); // generate interrupt
    outb(0x1f2, 1); // how many sectors?
    outb(0x1f3, b->sector & 0xff); // LBA goes here ...
    outb(0x1f4, (b->sector >> 8) & 0xff); // ... and here!
    outb(0x1f5, (b->sector >> 16) & 0xff); // ... and here!
    outb(0x1f6, 0xe0 | ((b->dev&1)<<4) | ((b->sector>>24)&0x0f));
    if(b->flags & B_DIRTY){
        outb(0x1f7, IDE_CMD_WRITE); // this is a WRITE
        outsl(0x1f0, b->data, 512/4); // transfer data too!
    } else {
        outb(0x1f7, IDE_CMD_READ); // this is a READ (no data)
    }
}

void ide_rw(struct buf *b) {
    acquire(&ide_lock);
    for (struct buf **pp = &ide_queue; *pp; pp=&(*pp)->qnext)
        ; // walk queue
    *pp = b; // add request to end
    if (ide_queue == b) // if q is empty
        ide_start_request(b); // send req to disk
    while ((b->flags & (B_VALID|B_DIRTY)) != B_VALID)
        sleep(b, &ide_lock); // wait for completion
    release(&ide_lock);
}

void ide_intr() {
    struct buf *b;
    acquire(&ide_lock);
    if (!(b->flags & B_DIRTY) && ide_wait_ready() >= 0)
        insl(0x1f0, b->data, 512/4); // if READ: get data
    b->flags |= B_VALID;
    b->flags &= ~B_DIRTY;
    wakeup(b); // wake waiting process
    if ((ide_queue = b->qnext) != 0) // start next request
        ide_start_request(ide_queue); // (if one exists)
    release(&ide_lock);
}

```

Figure 36.5: The xv6 IDE Disk Driver (Simplified)

case, the routine waits for the request to complete and the calling process is put to sleep. The second is `ide_start_request()`, which is used to send a request (and perhaps data, in the case of a write) to the disk; the `in` and `out` x86 instructions are called to read and write device registers, respectively. The start request routine uses the third function, `ide_wait_ready()`, to ensure the drive is ready before issuing a request to it. Finally, `ide_intr()` is invoked when an interrupt takes place; it reads data from the device (if the request is a read, not a write), wakes the process waiting for the I/O to complete, and (if there are more requests in the I/O queue), launches the next I/O via `ide_start_request()`.

## 36.9 Historical Notes

Before ending, we include a brief historical note on the origin of some of these fundamental ideas. If you are interested in learning more, read Smotherman's excellent summary [S08].

Interrupts are an ancient idea, existing on the earliest of machines. For example, the UNIVAC in the early 1950's had some form of interrupt vectoring, although it is unclear in exactly which year this feature was available [S08]. Sadly, even in its infancy, we are beginning to lose the origins of computing history.

There is also some debate as to which machine first introduced the idea of DMA. For example, Knuth and others point to the DYSEAC (a "mobile" machine, which at the time meant it could be hauled in a trailer), whereas others think the IBM SAGE may have been the first [S08]. Either way, by the mid 50's, systems with I/O devices that communicated directly with memory and interrupted the CPU when finished existed.

The history here is difficult to trace because the inventions are tied to real, and sometimes obscure, machines. For example, some think that the Lincoln Labs TX-2 machine was first with vectored interrupts [S08], but this is hardly clear.

Because the ideas are relatively obvious — no Einsteinian leap is required to come up with the idea of letting the CPU do something else while a slow I/O is pending — perhaps our focus on "who first?" is misguided. What is certainly clear: as people built these early machines, it became obvious that I/O support was needed. Interrupts, DMA, and related ideas are all direct outcomes of the nature of fast CPUs and slow devices; if you were there at the time, you might have had similar ideas.

## 36.10 Summary

You should now have a very basic understanding of how an OS interacts with a device. Two techniques, the interrupt and DMA, have been introduced to help with device efficiency, and two approaches to accessing device registers, explicit I/O instructions and memory-mapped I/O, have been described. Finally, the notion of a device driver has been presented, showing how the OS itself can encapsulate low-level details and thus make it easier to build the rest of the OS in a device-neutral fashion.

## References

- [A+11] “vIC: Interrupt Coalescing for Virtual Machine Storage Device IO”  
Irfan Ahmad, Ajay Gulati, Ali Mashtizadeh  
USENIX '11  
*A terrific survey of interrupt coalescing in traditional and virtualized environments.*
- [C01] “An Empirical Study of Operating System Errors”  
Andy Chou, Junfeng Yang, Benjamin Chelf, Seth Hallem, Dawson Engler  
SOSP '01  
*One of the first papers to systematically explore how many bugs are in modern operating systems. Among other neat findings, the authors show that device drivers have something like seven times more bugs than mainline kernel code.*
- [CK+08] “The xv6 Operating System”  
Russ Cox, Frans Kaashoek, Robert Morris, Nickolai Zeldovich  
From: <http://pdos.csail.mit.edu/6.828/2008/index.html>  
*See `ide.c` for the IDE device driver, with a few more details therein.*
- [D07] “What Every Programmer Should Know About Memory”  
Ulrich Drepper  
November, 2007  
Available: <http://www.akkadia.org/drepper/cpumemory.pdf>  
*A fantastic read about modern memory systems, starting at DRAM and going all the way up to virtualization and cache-optimized algorithms.*
- [G08] “EIO: Error-handling is Occasionally Correct”  
Haryadi Gunawi, Cindy Rubio-Gonzalez, Andrea Arpaci-Dusseau, Remzi Arpaci-Dusseau, Ben Liblit  
FAST '08, San Jose, CA, February 2008  
*Our own work on building a tool to find code in Linux file systems that does not handle error return properly. We found hundreds and hundreds of bugs, many of which have now been fixed.*
- [L94] “AT Attachment Interface for Disk Drives”  
Lawrence J. Lamers, X3T10 Technical Editor  
Available: <ftp://ftp.t10.org/t13/project/d0791r4c-ATA-1.pdf>  
Reference number: ANSI X3.221 - 1994 *A rather dry document about device interfaces. Read it at your own peril.*
- [MR96] “Eliminating Receive Livelock in an Interrupt-driven Kernel”  
Jeffrey Mogul and K. K. Ramakrishnan  
USENIX '96, San Diego, CA, January 1996  
*Mogul and colleagues did a great deal of pioneering work on web server network performance. This paper is but one example.*
- [S08] “Interrupts”  
Mark Smotherman, as of July '08  
Available: <http://people.cs.clemson.edu/~mark/interrupts.html>  
*A treasure trove of information on the history of interrupts, DMA, and related early ideas in computing.*

[S03] "Improving the Reliability of Commodity Operating Systems"

Michael M. Swift, Brian N. Bershad, and Henry M. Levy

SOSP '03

*Swift's work revived interest in a more microkernel-like approach to operating systems; minimally, it finally gave some good reasons why address-space based protection could be useful in a modern OS.*

[W10] "Hard Disk Driver"

Washington State Course Homepage

Available: <http://eecs.wsu.edu/~cs460/cs560/HDdriver.html>

*A nice summary of a simple IDE disk drive's interface and how to build a device driver for it.*