

Introduction to CMOS VLSI Design

Lecture 5: Logical Effort

David Harris

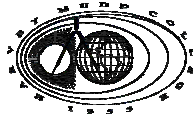

Harvey Mudd College
Spring 2004

Outline

- Introduction
- Delay in a Logic Gate
- Multistage Logic Networks
- Choosing the Best Number of Stages
- Example
- Summary

Introduction

- ❑ Chip designers face a bewildering array of choices
 - What is the best circuit topology for a function?
 - How many stages of logic give least delay?
 - How wide should the transistors be?

- ❑ Logical effort is a method to make these decisions
 - Uses a simple model of delay
 - Allows back-of-the-envelope calculations
 - Helps make rapid comparisons between alternatives
 - Emphasizes remarkable symmetries

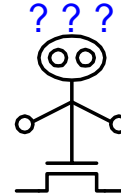

Example

- ❑ Ben Bitdiddle is the memory designer for the Motoroil 68W86, an embedded automotive processor. Help Ben design the decoder for a register file.

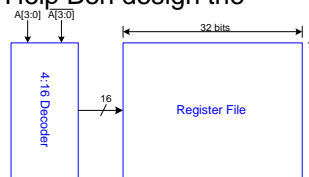

- ❑ Decoder specifications:
 - 16 word register file
 - Each word is 32 bits wide
 - Each bit presents load of 3 unit-sized transistors
 - True and complementary address inputs $A[3:0]$
 - Each input may drive 10 unit-sized transistors

- ❑ Ben needs to decide:
 - How many stages to use?
 - How large should each gate be?
 - How fast can decoder operate?

Delay in a Logic Gate

- Express delays in process-independent unit

$$d = \frac{d_{abs}}{\tau}$$

$$\tau = 3RC$$

≈ 12 ps in 180 nm process

40 ps in 0.6 μm process

Delay in a Logic Gate

- Express delays in process-independent unit

$$d = \frac{d_{abs}}{\tau}$$

- Delay has two components

$$d = f + p$$

Delay in a Logic Gate

- ❑ Express delays in process-independent unit

$$d = \frac{d_{abs}}{\tau}$$

- ❑ Delay has two components

$$d = f + p$$

- ❑ Effort delay $f = gh$ (a.k.a. stage effort)
 - Again has two components

5: Logical Effort

CMOS VLSI Design

Slide 7

Delay in a Logic Gate

- ❑ Express delays in process-independent unit

$$d = \frac{d_{abs}}{\tau}$$

- ❑ Delay has two components

$$d = f + p$$

- ❑ Effort delay $f = gh$ (a.k.a. stage effort)
 - Again has two components
- ❑ g : logical effort
 - Measures relative ability of gate to deliver current
 - $g \equiv 1$ for inverter

5: Logical Effort

CMOS VLSI Design

Slide 8

Delay in a Logic Gate

- ❑ Express delays in process-independent unit

$$d = \frac{d_{abs}}{\tau}$$

- ❑ Delay has two components

$$d = f + p$$

- ❑ Effort delay $f = gh$ (a.k.a. stage effort)

- Again has two components

- ❑ h : electrical effort = C_{out} / C_{in}

- Ratio of output to input capacitance

- Sometimes called fanout

Delay in a Logic Gate

- ❑ Express delays in process-independent unit

$$d = \frac{d_{abs}}{\tau}$$

- ❑ Delay has two components

$$d = f + p$$

- ❑ Parasitic delay p

- Represents delay of gate driving no load

- Set by internal parasitic capacitance

Delay Plots

$$d = f + p$$

$$= gh + p$$

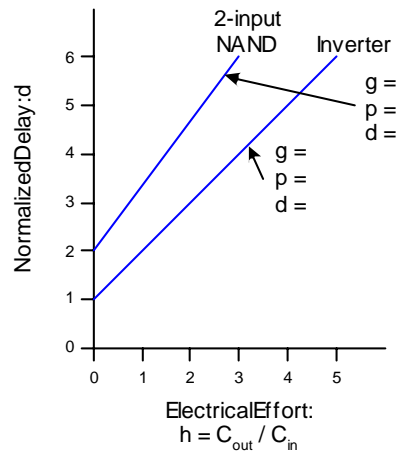

5: Logical Effort

CMOS VLSI Design

Slide 11

Delay Plots

$$d = f + p$$

$$= gh + p$$

□ What about NOR2?

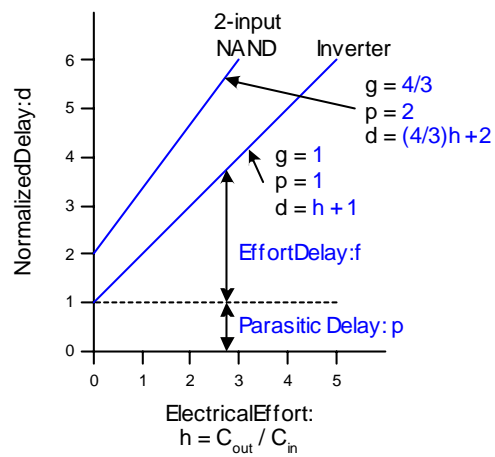

5: Logical Effort

CMOS VLSI Design

Slide 12

Computing Logical Effort

- ❑ DEF: *Logical effort is the ratio of the input capacitance of a gate to the input capacitance of an inverter delivering the same output current.*
- ❑ Measure from delay vs. fanout plots
- ❑ Or estimate by counting transistor widths

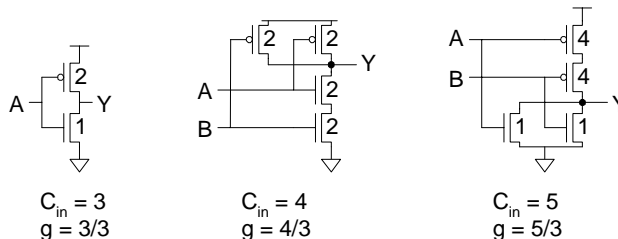

5: Logical Effort

CMOS VLSI Design

Slide 13

Catalog of Gates

- ❑ Logical effort of common gates

Gate type	Number of inputs				
	1	2	3	4	n
Inverter	1				
NAND		4/3	5/3	6/3	(n+2)/3
NOR		5/3	7/3	9/3	(2n+1)/3
Tristate / mux	2	2	2	2	2
XOR, XNOR		4, 4	6, 12, 6	8, 16, 16, 8	

5: Logical Effort

CMOS VLSI Design

Slide 14

Catalog of Gates

- Parasitic delay of common gates
 - In multiples of p_{inv} (≈ 1)

Gate type	Number of inputs				
	1	2	3	4	n
Inverter	1				
NAND		2	3	4	n
NOR		2	3	4	n
Tristate / mux	2	4	6	8	2n
XOR, XNOR		4	6	8	

5: Logical Effort

CMOS VLSI Design

Slide 15

Example: Ring Oscillator

- Estimate the frequency of an N-stage ring oscillator

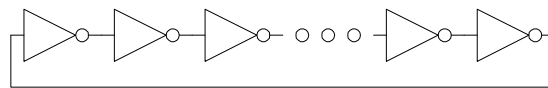

Logical Effort: $g =$

Electrical Effort: $h =$

Parasitic Delay: $p =$

Stage Delay: $d =$

Frequency: $f_{osc} =$

5: Logical Effort

CMOS VLSI Design

Slide 16

Example: Ring Oscillator

- Estimate the frequency of an N-stage ring oscillator

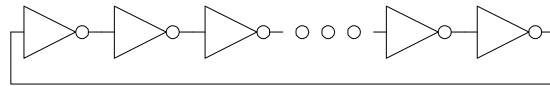

Logical Effort: $g = 1$

Electrical Effort: $h = 1$

Parasitic Delay: $p = 1$

Stage Delay: $d = 2$

Frequency: $f_{osc} = 1/(2 \cdot N \cdot d) = 1/4N$

31 stage ring oscillator in
0.6 μm process has
frequency of ~ 200 MHz

Example: FO4 Inverter

- Estimate the delay of a fanout-of-4 (FO4) inverter

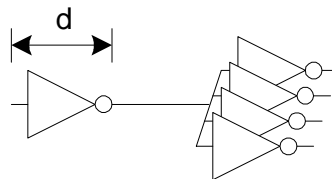

Logical Effort: $g =$

Electrical Effort: $h =$

Parasitic Delay: $p =$

Stage Delay: $d =$

Example: FO4 Inverter

- Estimate the delay of a fanout-of-4 (FO4) inverter

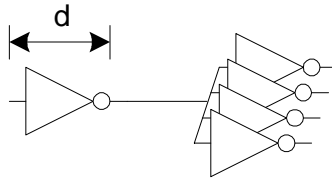

Logical Effort: $g = 1$

Electrical Effort: $h = 4$

Parasitic Delay: $p = 1$

Stage Delay: $d = 5$

The FO4 delay is about

200 ps in 0.6 μm process

60 ps in a 180 nm process

$f/3$ ns in an f μm process

5: Logical Effort

CMOS VLSI Design

Slide 19

Multistage Logic Networks

- Logical effort generalizes to multistage networks

- Path Logical Effort $G = \prod g_i$

- Path Electrical Effort $H = \frac{C_{\text{out-path}}}{C_{\text{in-path}}}$

- Path Effort $F = \prod f_i = \prod g_i h_i$

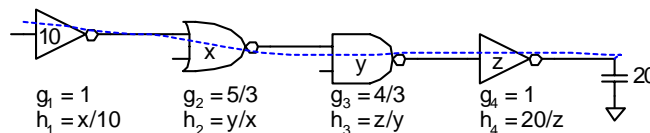

5: Logical Effort

CMOS VLSI Design

Slide 20

Multistage Logic Networks

- ❑ Logical effort generalizes to multistage networks

- ❑ *Path Logical Effort* $G = \prod g_i$

- ❑ *Path Electrical Effort* $H = \frac{C_{out-path}}{C_{in-path}}$

- ❑ *Path Effort* $F = \prod f_i = \prod g_i h_i$

- ❑ Can we write $F = GH$?

Paths that Branch

- ❑ No! Consider paths that branch:

$G =$
 $H =$
 $GH =$
 $h_1 =$
 $h_2 =$
 $F = GH?$

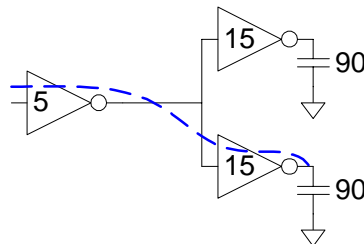

Paths that Branch

- ❑ No! Consider paths that branch:

$$\begin{aligned}
 G &= 1 \\
 H &= 90 / 5 = 18 \\
 GH &= 18 \\
 h_1 &= (15 + 15) / 5 = 6 \\
 h_2 &= 90 / 15 = 6 \\
 F &= g_1 g_2 h_1 h_2 = 36 = 2GH
 \end{aligned}$$

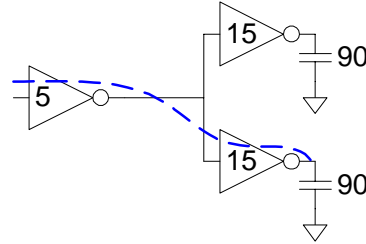

5: Logical Effort

CMOS VLSI Design

Slide 23

Branching Effort

- ❑ Introduce *branching effort*
 - Accounts for branching between stages in path

$$b = \frac{C_{\text{on path}} + C_{\text{off path}}}{C_{\text{on path}}}$$

$$B = \prod b_i$$

Note:

$$\prod h_i = BH$$

- ❑ Now we compute the path effort
 - $F = GBH$

5: Logical Effort

CMOS VLSI Design

Slide 24

Multistage Delays

- ❑ Path Effort Delay $D_F = \sum f_i$
- ❑ Path Parasitic Delay $P = \sum p_i$
- ❑ Path Delay $D = \sum d_i = D_F + P$

5: Logical Effort

CMOS VLSI Design

Slide 25

Designing Fast Circuits

$$D = \sum d_i = D_F + P$$

- ❑ Delay is smallest when each stage bears same effort

$$\hat{f} = g_i h_i = F^{\frac{1}{N}}$$

- ❑ Thus minimum delay of N stage path is

$$D = NF^{\frac{1}{N}} + P$$

- ❑ This is a **key** result of logical effort
 - Find fastest possible delay
 - Doesn't require calculating gate sizes

5: Logical Effort

CMOS VLSI Design

Slide 26

Gate Sizes

- How wide should the gates be for least delay?

$$\hat{f} = gh = g \frac{C_{out}}{C_{in}}$$
$$\Rightarrow C_{in_i} = \frac{g_i C_{out_i}}{\hat{f}}$$

- Working backward, apply capacitance transformation to find input capacitance of each gate given load it drives.
- Check work by verifying input cap spec is met.

5: Logical Effort

CMOS VLSI Design

Slide 27

Example: 3-stage path

- Select gate sizes x and y for least delay from A to B

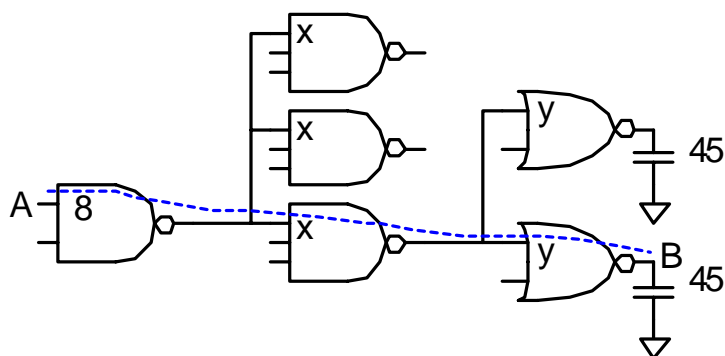

5: Logical Effort

CMOS VLSI Design

Slide 28

Example: 3-stage path

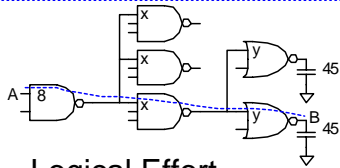

Logical Effort	$G =$
Electrical Effort	$H =$
Branching Effort	$B =$
Path Effort	$F =$
Best Stage Effort	$\hat{f} =$
Parasitic Delay	$P =$
Delay	$D =$

5: Logical Effort

CMOS VLSI Design

Slide 29

Example: 3-stage path

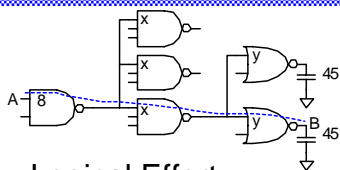

Logical Effort	$G = (4/3) * (5/3) * (5/3) = 100/27$
Electrical Effort	$H = 45/8$
Branching Effort	$B = 3 * 2 = 6$
Path Effort	$F = GBH = 125$
Best Stage Effort	$\hat{f} = \sqrt[3]{F} = 5$
Parasitic Delay	$P = 2 + 3 + 2 = 7$
Delay	$D = 3 * 5 + 7 = 22 = 4.4 \text{ FO4}$

5: Logical Effort

CMOS VLSI Design

Slide 30

Example: 3-stage path

- Work backward for sizes

y =

x =

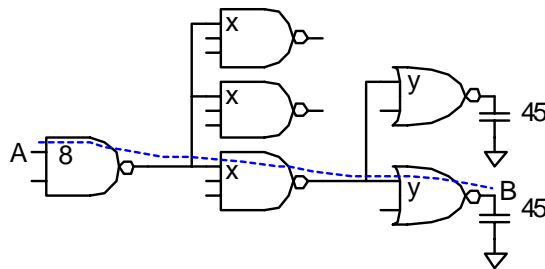

5: Logical Effort

CMOS VLSI Design

Slide 31

Example: 3-stage path

- Work backward for sizes

$$y = 45 * (5/3) / 5 = 15$$

$$x = (15 * 2) * (5/3) / 5 = 10$$

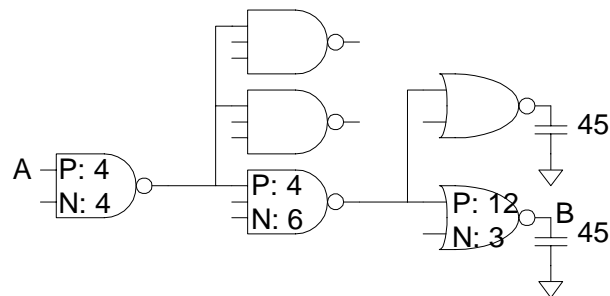

5: Logical Effort

CMOS VLSI Design

Slide 32

Best Number of Stages

- ❑ How many stages should a path use?
 - Minimizing number of stages is not always fastest
- ❑ Example: drive 64-bit datapath with unit inverter

D =

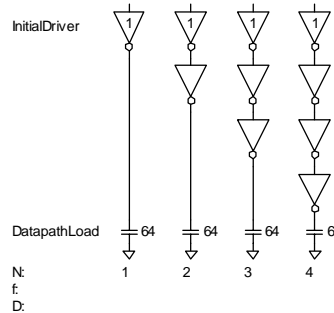

Best Number of Stages

- ❑ How many stages should a path use?
 - Minimizing number of stages is not always fastest
- ❑ Example: drive 64-bit datapath with unit inverter

$$D = NF^{1/N} + P$$

$$= N(64)^{1/N} + N$$

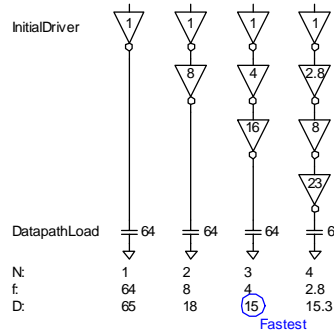

Derivation

- Consider adding inverters to end of path
 - How many give least delay?

$$D = NF^{\frac{1}{N}} + \sum_{i=1}^{n_1} p_i + (N - n_1) p_{inv}$$

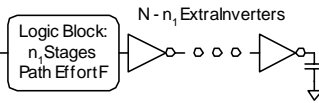

$$\frac{\partial D}{\partial N} = -F^{\frac{1}{N}} \ln F^{\frac{1}{N}} + F^{\frac{1}{N}} + p_{inv} = 0$$

- Define best stage effort $\rho = F^{\frac{1}{N}}$

$$p_{inv} + \rho(1 - \ln \rho) = 0$$

Best Stage Effort

- $p_{inv} + \rho(1 - \ln \rho) = 0$ has no closed-form solution
- Neglecting parasitics ($p_{inv} = 0$), we find $\rho = 2.718$ (e)
- For $p_{inv} = 1$, solve numerically for $\rho = 3.59$

Sensitivity Analysis

- How sensitive is delay to using exactly the best number of stages?

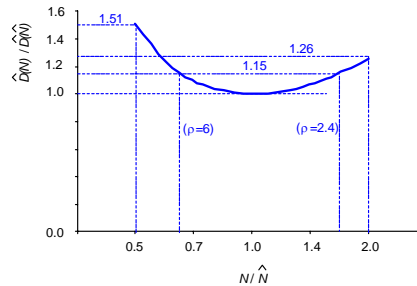

- $2.4 < \rho < 6$ gives delay within 15% of optimal
 - We can be sloppy!
 - I like $\rho = 4$

Example, Revisited

- Ben Bitdiddle is the memory designer for the Motoroil 68W86, an embedded automotive processor. Help Ben design the decoder for a register file.

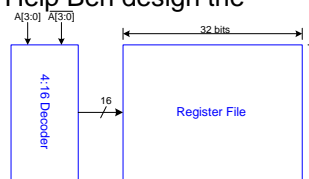

- Decoder specifications:
 - 16 word register file
 - Each word is 32 bits wide
 - Each bit presents load of 3 unit-sized transistors
 - True and complementary address inputs $A[3:0]$
 - Each input may drive 10 unit-sized transistors
- Ben needs to decide:
 - How many stages to use?
 - How large should each gate be?
 - How fast can decoder operate?

Number of Stages

- ❑ Decoder effort is mainly electrical and branching

Electrical Effort: $H =$

Branching Effort: $B =$

- ❑ If we neglect logical effort (assume $G = 1$)

Path Effort: $F =$

Number of Stages: $N =$

Number of Stages

- ❑ Decoder effort is mainly electrical and branching

Electrical Effort: $H = (32 \cdot 3) / 10 = 9.6$

Branching Effort: $B = 8$

- ❑ If we neglect logical effort (assume $G = 1$)

Path Effort: $F = GBH = 76.8$

Number of Stages: $N = \log_4 F = 3.1$

- ❑ Try a 3-stage design

Gate Sizes & Delay

Logical Effort: $G =$
 Path Effort: $F =$
 Stage Effort: $\hat{f} =$
 Path Delay: $D =$
 Gate sizes: $z =$ $y =$

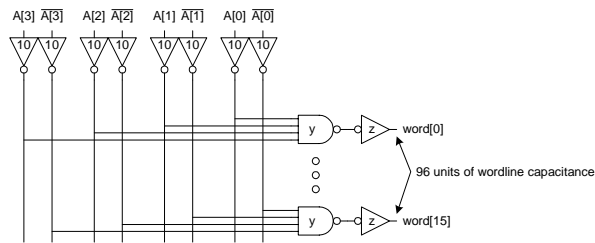

5: Logical Effort

CMOS VLSI Design

Slide 41

Gate Sizes & Delay

Logical Effort: $G = 1 * 6/3 * 1 = 2$
 Path Effort: $F = GBH = 154$
 Stage Effort: $\hat{f} = F^{1/3} = 5.36$
 Path Delay: $D = 3\hat{f} + 1 + 4 + 1 = 22.1$
 Gate sizes: $z = 96 * 1/5.36 = 18$ $y = 18 * 2/5.36 = 6.7$

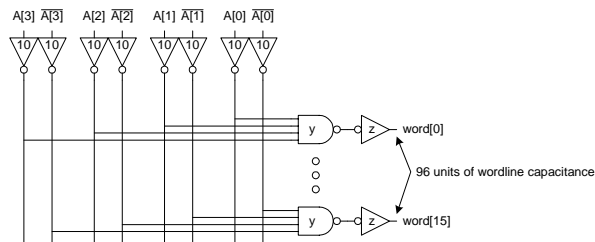

5: Logical Effort

CMOS VLSI Design

Slide 42

Comparison

- Compare many alternatives with a spreadsheet

Design	N	G	P	D
NAND4-INV	2	2	5	29.8
NAND2-NOR2	2	20/9	4	30.1
INV-NAND4-INV	3	2	6	22.1
NAND4-INV-INV-INV	4	2	7	21.1
NAND2-NOR2-INV-INV	4	20/9	6	20.5
NAND2-INV-NAND2-INV	4	16/9	6	19.7
INV-NAND2-INV-NAND2-INV	5	16/9	7	20.4
NAND2-INV-NAND2-INV-INV-INV	6	16/9	8	21.6

5: Logical Effort

CMOS VLSI Design

Slide 43

Review of Definitions

Term	Stage	Path
number of stages	1	N
logical effort	g	$G = \prod g_i$
electrical effort	$h = \frac{C_{out}}{C_{in}}$	$H = \frac{C_{out-path}}{C_{in-path}}$
branching effort	$b = \frac{C_{on-path} + C_{off-path}}{C_{on-path}}$	$B = \prod b_i$
effort	$f = gh$	$F = GBH$
effort delay	f	$D_F = \sum f_i$
parasitic delay	p	$P = \sum p_i$
delay	$d = f + p$	$D = \sum d_i = D_F + P$

5: Logical Effort

CMOS VLSI Design

Slide 44

Method of Logical Effort

- 1) Compute path effort $F = GBH$
- 2) Estimate best number of stages $N = \log_4 F$
- 3) Sketch path with N stages
- 4) Estimate least delay $D = NF^{\frac{1}{N}} + P$
- 5) Determine best stage effort $\hat{f} = F^{\frac{1}{N}}$
- 6) Find gate sizes $C_{in_i} = \frac{g_i C_{out_i}}{\hat{f}}$

Limits of Logical Effort

- Chicken and egg problem
 - Need path to compute G
 - But don't know number of stages without G
- Simplistic delay model
 - Neglects input rise time effects
- Interconnect
 - Iteration required in designs with wire
- Maximum speed only
 - Not minimum area/power for constrained delay

Summary

- ❑ Logical effort is useful for thinking of delay in circuits
 - Numeric logical effort characterizes gates
 - NANDs are faster than NORs in CMOS
 - Paths are fastest when effort delays are ~ 4
 - Path delay is weakly sensitive to stages, sizes
 - But using fewer stages doesn't mean faster paths
 - Delay of path is about $\log_4 F$ FO4 inverter delays
 - Inverters and NAND2 best for driving large caps
- ❑ Provides language for discussing fast circuits
 - But requires practice to master