

Final Assembly

- ▶ Your final project chip consists of a core and a pad ring
 - ▶ Core is the guts
 - ▶ Pad ring (or pad frame) connects the guts to the outside world
- ▶ It's critical to do a functional simulation of your whole chip, including the pads!
 - ▶ Make sure you can drive the chip from the external interface
 - ▶ Make sure you have the core connected to the pads correctly.

Chip Core

- ▶ The Chip Core is everything that is inside the Pad Ring
 - ▶ Try to floorplan your core so that it's as small a rectangle as possible
 - ▶ At the very least, make sure it fits in the frame you've chosen
 - ▶ Make sure to connect vdd and gnd in the core!
 - ▶ This core can be DRC and LVS checked
 - ▶ This core can be simulated for functionality
 - ▶ This core is then routed to the pads

Core Sizes

- ▶ All things are in terms of Tiny Chip Units (TCUs)
 - ▶ 1 TCU = 1.5x1.5mm outside dimension
 - ▶ 1 TCU = 900x900 usable core area
 - ▶ 2 TCU = 900x2300 usable core area
 - ▶ 4 TCU = 2300x2300 usable core area
- ▶ More on this later!

Connecting Core to Pads

- ▶ Once your core is complete, you need to connect it to the pad frame
 - ▶ Then you re-do the functional simulation, but through the pads this time
 - ▶ You should be able to re-use your testfixture
 - ▶ Also a final DRC and LVS which includes the pads
- ▶ Use **ccar** for connecting the core to the pads!

Core

- ▶ The guts of your chip

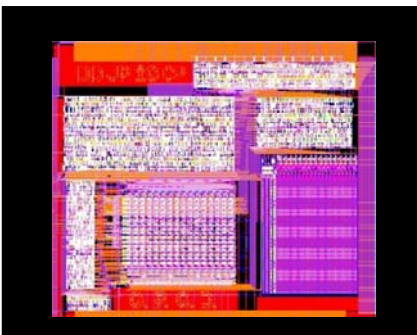

Pad Ring

- ▶ The connection to the outside world



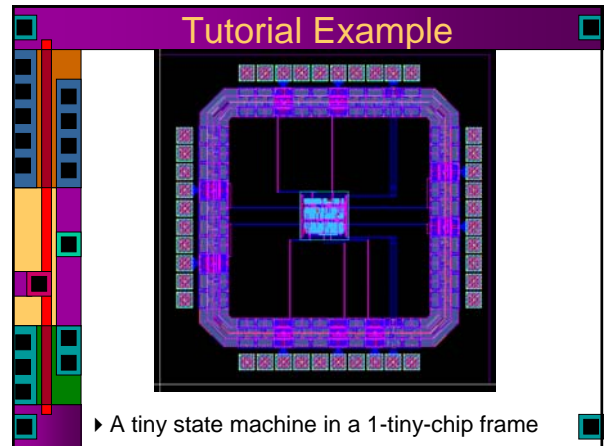
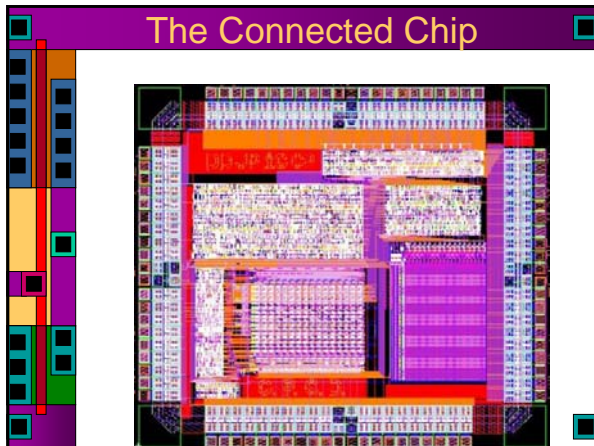

Pad Cells

- ▶ Started with a set of pads from MOSIS
 - ▶ Originally from Tanner Tools pads
 - ▶ Problem: the pads don't DRC, LVS, or simulate!
- ▶ Cameron Charles from Reid's group re-did the cells in 2002 to fix these issues
- ▶ Result is **UofU_Pads**
 - ▶ `/uusoc/facility/cad_common/local/Cadence/lib/UofU_Pads`
 - ▶ Use library manager to add this library
 - ▶ Name it UofU_Pads
 - ▶ They now DRC, LVS, and simulate!

Driving Large Capacitances

$$t_{pHL} = \frac{C_L V_{swing}/2}{I_{av}}$$

Transistor Sizing

Using Cascaded Buffers

$U_{opt} = e$?

How to Design Large Transistors

(a) small transistors in parallel (b) circular transistors

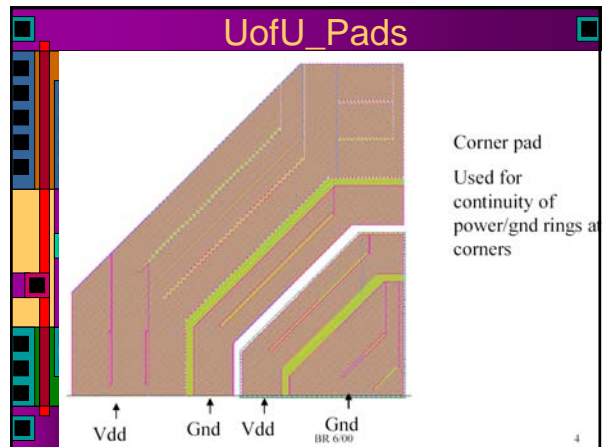
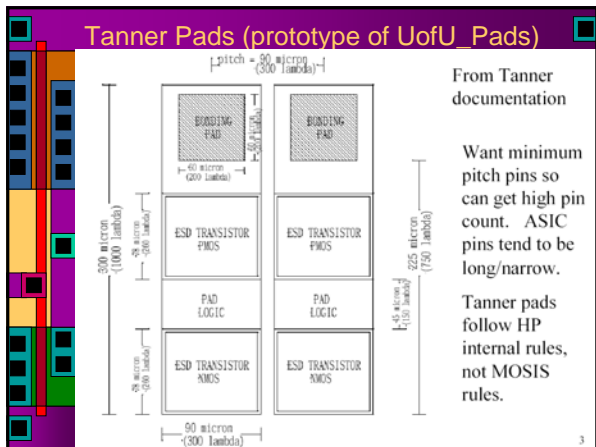
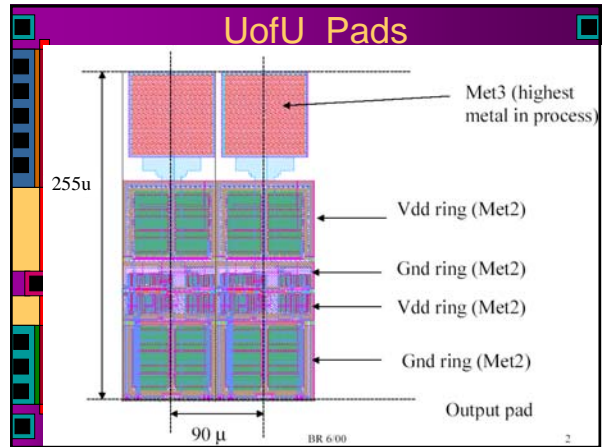
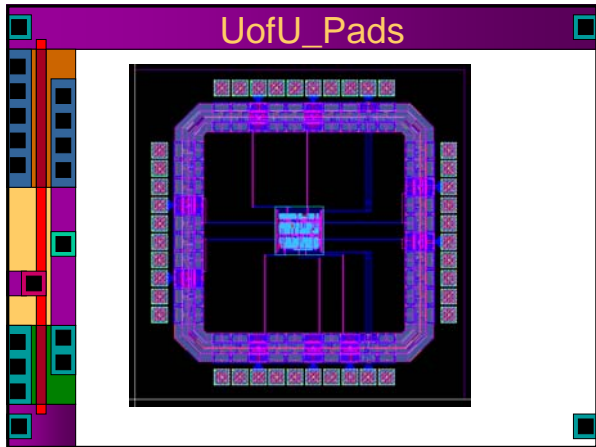
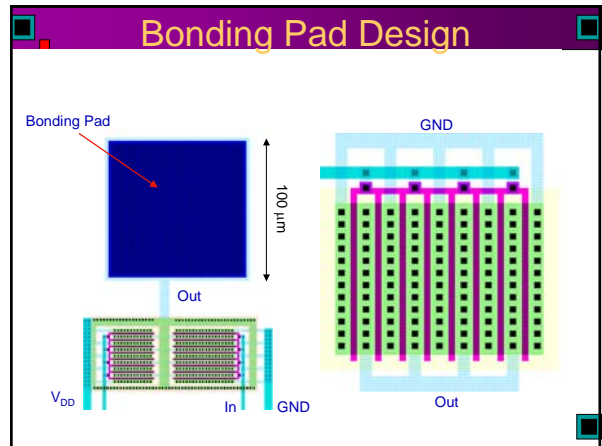
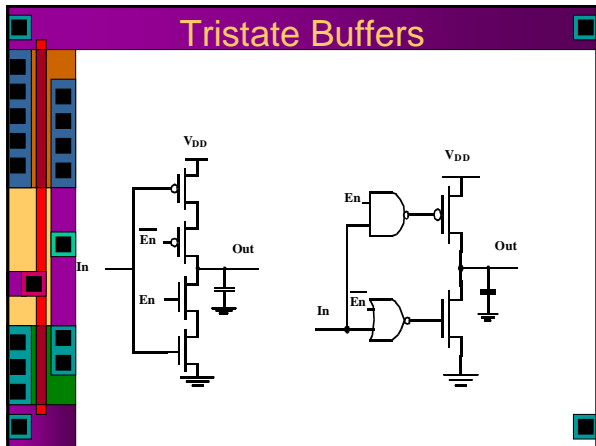

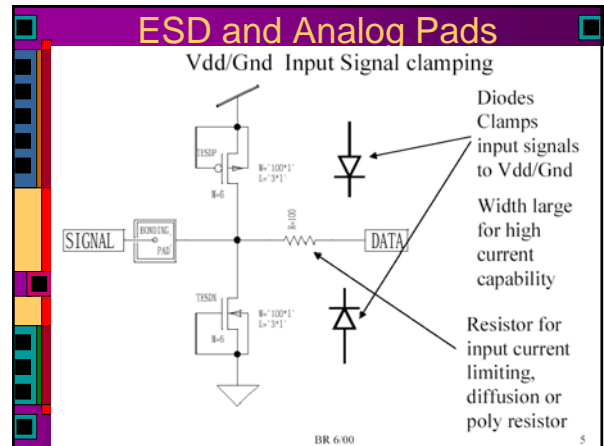
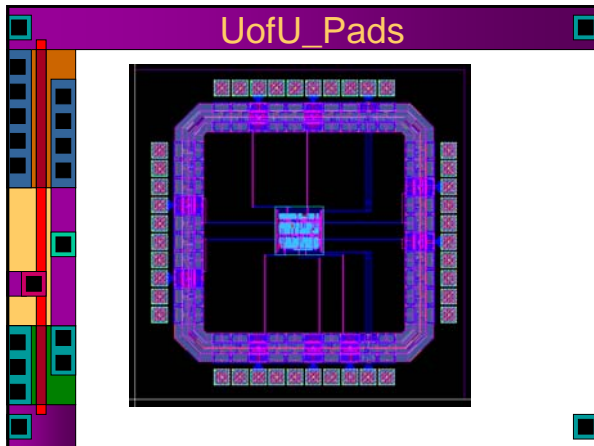

ESD Protection

A thick film device built from Met1, field oxide, and diffusion is used for ESD protection.

Field oxide device usually has threshold voltage in the 10's of volts.

Metal 1 provides 'gate' of device, tied to pad, also tied to drain.

Width of device is very high to provide low on resistance, high current density.

Will handle any short duration spikes due to electro static discharge.

Most processes have special high threshold transistors that can be used for ESD protection instead of field oxide devices.

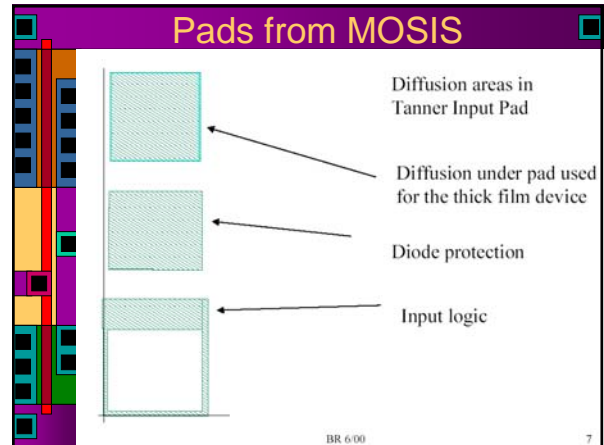

ASIC Pads

- Most ASIC pads have multiple Vdd/Gnd Rings
- Leda Systems 0.25u, 0.35u pad library has the following rings
 - Avdd, Avss -- analog VDD/Gnd
 - Evdd, Evss -- external Vdd/Gnd -- supports pads with different Vdd/Gnd from core
 - Nvdd, Nvss -- internal Vdd/Gnd -- core VDD/GND
 - Vss/Vdd -- ?? (also core Vdd/Gnd??)

UofU_Pads

- ▶ pad_bidirhe
 - ▶ Bidirectional pad with high enable
- ▶ pad_in
 - ▶ Digital input pad
- ▶ pad_out
 - ▶ Digital output pad
- ▶ pad_vdd, pad_gnd
 - ▶ Power supply pads
- ▶ pad_io, pad_io_nores
 - ▶ Analog pads (with and without series resistor)
- ▶ pad_nc, pad_space
 - ▶ Non-connecting pad and spacer

Pad Interfaces

- pad_bidirhe (bi-directional pad)

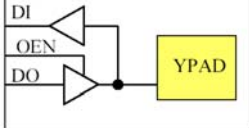

```

module pad_bidirhe (OEN,
DO, DI, YPAD);
input OEN; (EN)
input DO; (DataOut)
output DI; (DataIn, DataInB)
inout YPAD; (pad)

```

If OEN = '1', then YPAD = DO else YPAD = 'Z'.

- DataOut drives a 78(p) x 45(n) inverter (30x)
- Which then drives a 200(p) x 200(n) output driver (133x)
- DataIn and DataInB come from 96(p) x 54(n) inverters (36x)
- EN drives a 16(p) x 9(n) inverter (6x)
- All signal pads are built from this one
 - All signals on are M2

pad_bidirhe

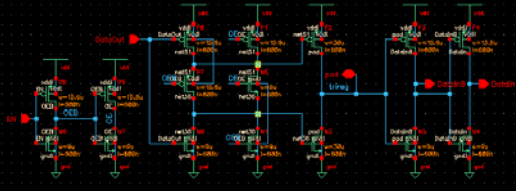

- Moderately complex pullup/pulldown structure

pad_bidirhe

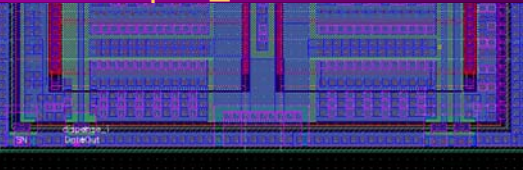

- M2 connections for EN, DataOut, DataIn, DataInB

pad_bidirhe

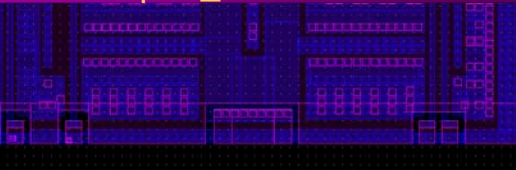

- Look at just the metal layers...
 - EN, DataOut, DataInB, DataIn is the order
 - Middle connection is direct connection to the pad (don't use it!)
 - You put metal2 shape pins over the connection points (for icc)

UofU Pads

- pad_out (output only pad)

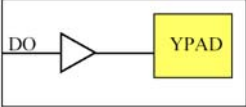

```

module pad_out (DO, YPAD);
output YPAD; (pad)
input DO; (DataOut)

```

- pad_in (input only pad)

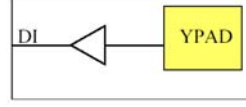

```

module pad_in (DI, YPAD);
output DI; (DataIn, DataInB)
input YPAD; (pad)

```

pad_out



- Like pad_bidirhe but with EN already tied high for you
 - All you need to connect is DataOut

pad_out

EN DataOut

▶ You connect your signal to the DataOut connection into 78(p) x 45(n) inv (30x)

pad_out

▶ You connect your signal to the DataOut connection into 78(p) x 45(n) inv (30x)

pad_in

▶ Like pad_bidirhe but with EN tied low already for you
▶ Connect to the DataInB and DataIn port

pad_in

▶ DataIn and DataInB provide input signals
▶ Driven from 94(p) x 54(n) inverters (36x)

Power Supply Pads

- pad_vdd (vdd pad, vdd to core and pad rings)

```

module pad_vdd (vdd, YPAD);
inout YPAD, vdd;

```

- pad_gnd (gnd pad, gnd to core and pad rings)

```

module pad_gnd (vdd, YPAD);
inout YPAD, gnd;

```

pad_vdd

▶ Vdd is on a big fat metal1 line
▶ 28.8u wide

pad_gnd

- ▶ GND is also on a big fat **metal1** line
- ▶ Also 28.8u

More Pads

- PADNC (filler pad)

YPAD module PADNC ();

A no-connection pad is used to fill out the padframe if you don't need the I/Os. Could also use extra Vdd/GND pads.

You don't want to use input/output pads with unconnected inputs because these can consume power if the inputs float.

Timetable

- ▶ Final Chip Assembly
 - ▶ Due **Wednesday December 13th**
 - ▶ Take the pad cells and make a pad ring
 - ▶ Connect your working core to the pad ring
- ▶ Remember that Tiny Chip Units are 1.5mm X 1.5mm and are not divisible
 - ▶ A 3.1mm X 2.8mm chip would cost 6 TCUs!
 - ▶ Preference will go to the well-simulated chips
 - ▶ Secondary preference will be for the smaller well-simulated chips

Available Frames

- ▶ Frame1_38
- ▶ Frame2h_70
- ▶ Frame2v_70
- ▶ Frame4_78
 - ▶ 1,2,4 indicate how many Tiny Chip Units
 - ▶ h and v indicate horizontal and vertical for the rectangular core frames
 - ▶ _# indicates how many signal pins are available
 - ▶ **Vdd and gnd are in the right spots – DON'T MOVE THEM!**

Frame1_38

40 pins total
(38 signal pins)
10 on each side

990 x 990 core

Save room for Routing to pads!
900 x 900 Usable core

Frame1_38

40 pins total
(38 signal pins)
10 on each side

990 x 990 core

Save room for Routing to pads!
900 x 900 Usable core

Frame1_38

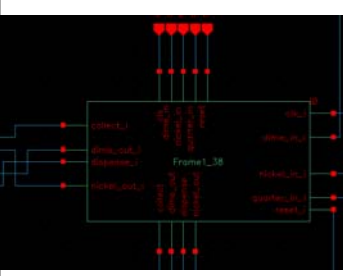

40 pins total
(38 signal pins)
10 on each side

990 x 990 core

Save room for Routing to pads!
900 x 900 Usable core

Example Frame1 Chip

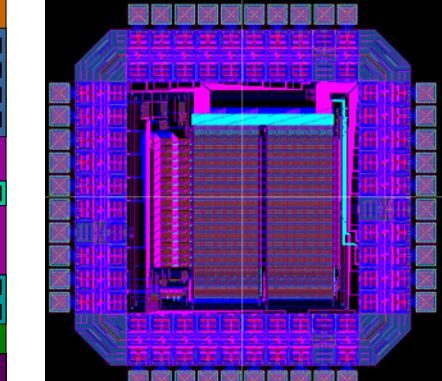

Example Frame1 Chip

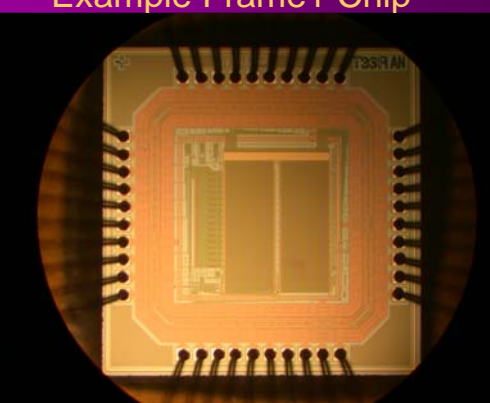

Frame2h_68

72 pins total, 70 signal pins
990 x 2430 core (900 x 2300 usable)

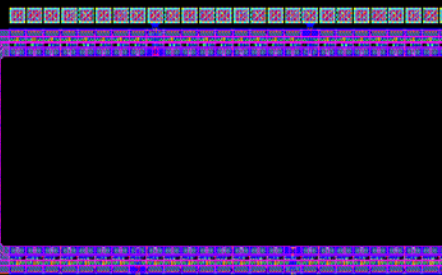

Frame2h_68

72 pins total, 68 signal pins
990 x 2430 core (900 x 2300 usable)

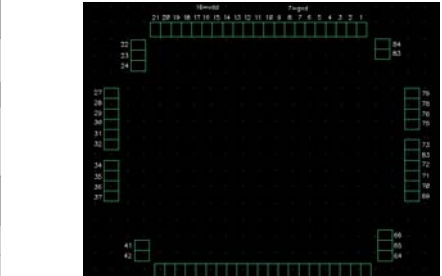

Frame4_78

84 total pins (78 signal pins)
2490 x 2490 (2300 x 2300 usable)

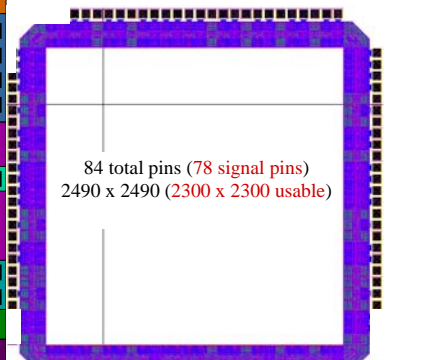

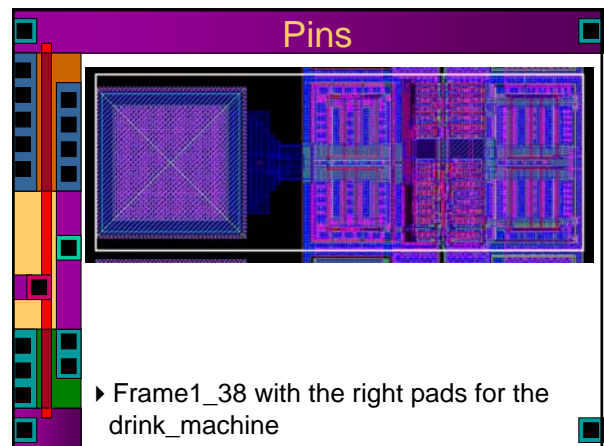
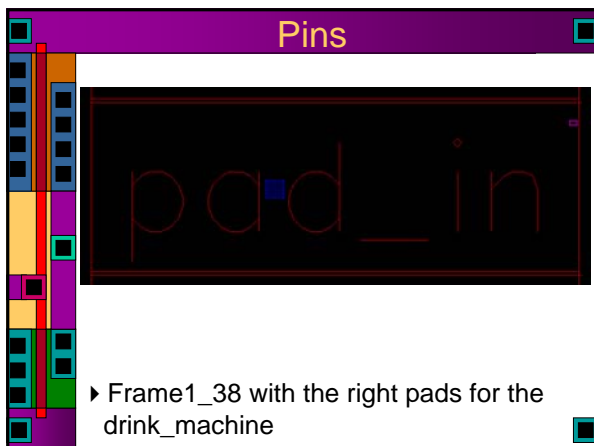
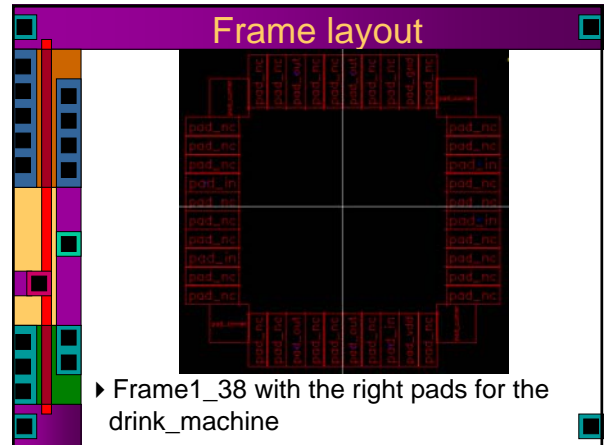
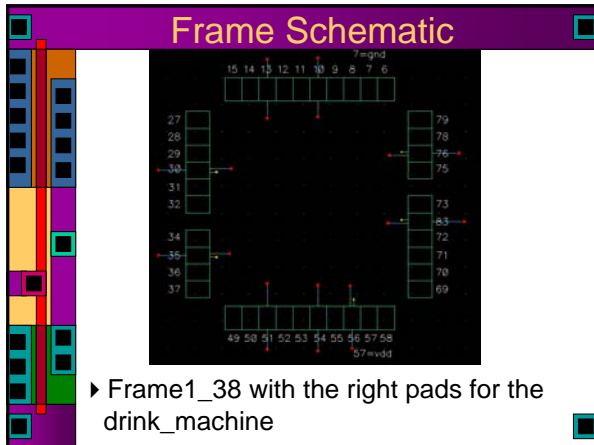
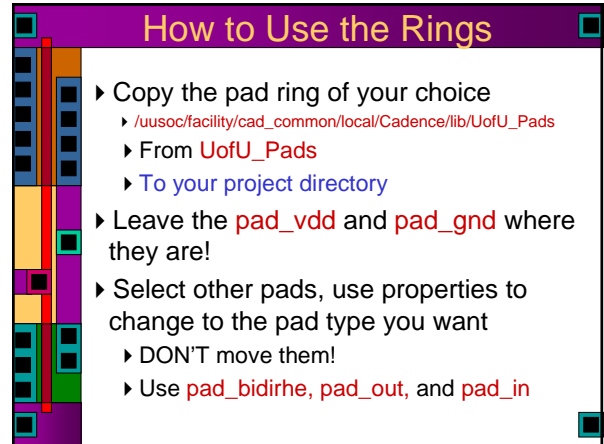
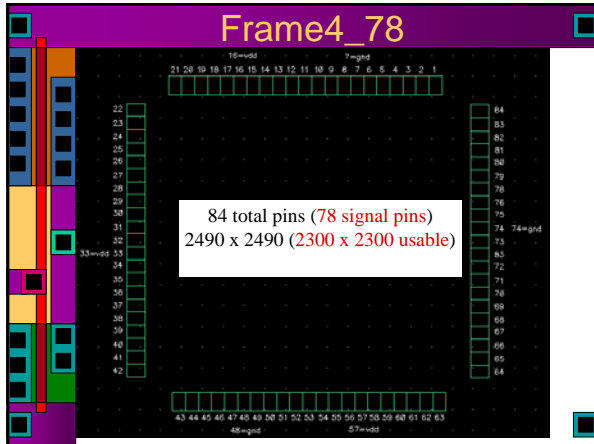

Frame symbol

▶ Frame1_38 with the right pads for the drink_machine

Connect to Core

▶ Use this to start the `ccar` routing process

Layout with Virtuoso-XL

▶ Do placement, and connect vdd and gnd

Connect with icc

▶ Let `ccar` the routing

Vdd Connections

▶ Notice how the pad frame is connected

Gnd Connections

▶ Notice how the pad frame is connected

Now Simulate the Whole Chip

- ▶ Use essentially the same testbench that you used for the core
 - ▶ This time you'll be simulating with the pads in place
 - ▶ You'll need to place one more set of pins so that the wholechip cell has connection points

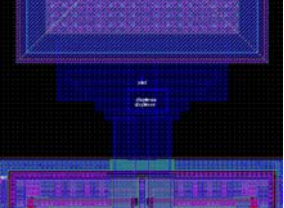

What Does This Mean?

- ▶ For now, concentrate on getting your chip core assembled, working, DRCed and LVSed.
 - ▶ You need a working core before you need pads!
- ▶ Make sure your core fits in the pad ring that you want to use
- ▶ Then, use **ccar** to assemble the frame and core
 - ▶ Simulate, LVS, DRC with the whole thing!

Output to GDS (Stream)

- ▶ Once everything is completely finished, you need to export the whole chip to **GDS (stream)** format
 - ▶ Use the `export->stream` function in CIW
 - ▶ In **User Defined Data**, use `stream4gds.map` as the **Layer Map Table**
 - ▶ From `/uusoc/facility/cad_common/local/class/6710/cadence/map_files`
- ▶ Fill in **Library Name**, **Top Cell Name** and **Output File Name**
- ▶ I will read this GDS file in and re-DRC that layout...

Fabrication Schedule

- ▶ MOSIS educational run closes on **Jan 8th**
 - ▶ Chips that go into the fab queue need to be absolutely and completely ready to go **a few days before that** because of high ftp traffic
 - ▶ Friday Jan 5th at the **LATEST**
- ▶ There are a few more steps that projects need to go through to make them fab-ready even after DRC/LVS
- ▶ If you make logos and names, those have to pass DRC too!
 - ▶ Metal3 is recommended for logos...

Final Report

- ▶ Final Report, due Wednesday Dec 13th
- ▶ **Three** parts:
 - ▶ **First:** Technical Paper (about project)
 - ▶ Not more than 10 pages
 - ▶ IEEE two-column format
 - ▶ Describe what makes your chip interesting
 - ▶ This is a self-contained paper of the form that might be submitted to a conference or journal
 - ▶ **Second:** Project Details
 - ▶ Floorplan, pinout, and system block diagram
 - ▶ Schematics and layouts for all major parts
 - ▶ A table of contents or readme guide

Final Report

- ▶ **Third:** Standard Cells
 - ▶ Standard Cell layouts, schematics, etc.
 - ▶ User's guide
 - ▶ Email `.lib`, `.lef`, and `.v` files to me at teach-cs6710@cs.utah.edu
 - ▶ Also tell me where your libraries are.
 - ▶ I can slurp up the cell libraries if they are readable by your group.